

BED, SHINGLE & SHOE MOULDING

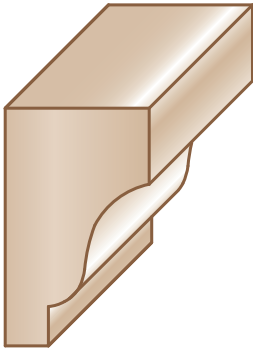

M520 Shingle
 a. $\frac{3}{4}'' \times 1 \frac{1}{4}''$
 b. $\frac{3}{4}'' \times 1 \frac{5}{8}''$

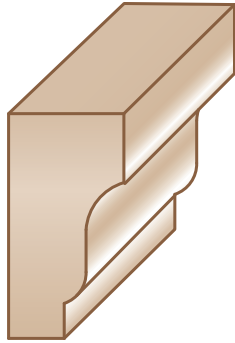

M500 Bed
 a. $\frac{1}{2}'' \times \frac{3}{4}''$
 b. $\frac{9}{16}'' \times 1 \frac{1}{8}''$
 c. $\frac{5}{8}'' \times 1 \frac{1}{2}''$



U731 Bed
 $\frac{5}{8}'' \times 1 \frac{1}{2}''$

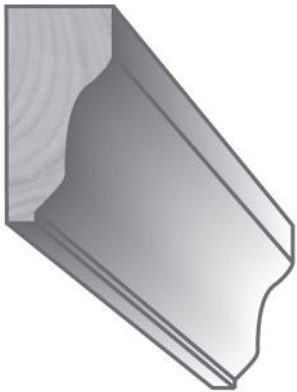

U732 Bed
 $\frac{9}{16}'' \times 1 \frac{1}{8}''$

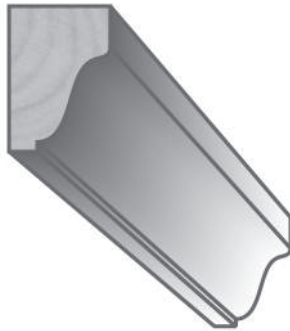

U733 Bed
 $\frac{1}{2}'' \times \frac{3}{4}''$

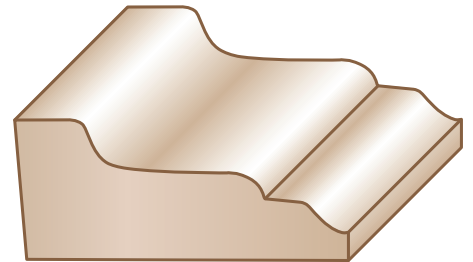

U734 Bed
 $\frac{3}{4}'' \times 1 \frac{3}{4}''$

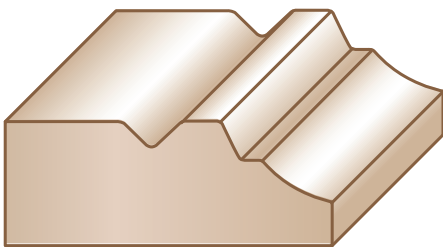

U735 Bed
 $1 \frac{1}{16}'' \times 1 \frac{5}{8}''$

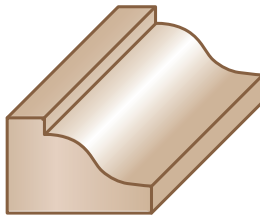

U736 Bed
 $\frac{1}{2}'' \times \frac{3}{4}''$

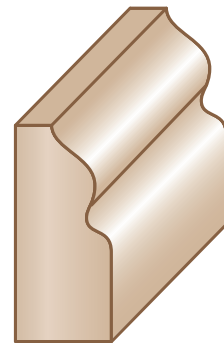

U769 Shoe
 $\frac{1}{2}'' \times 1 \frac{1}{8}''$

BED, SHINGLE & SHOE MOULDING CONTINUED

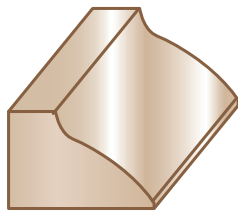

M101 Shoe
 $\frac{1}{2}'' \times \frac{3}{4}''$

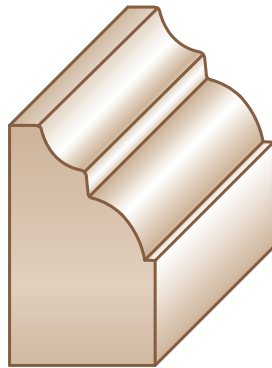

M531 Shoe
 $\frac{3}{4}'' \times 1 \frac{1}{4}''$

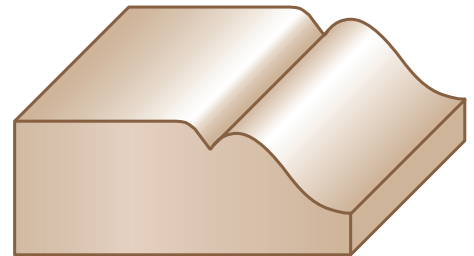

U768 Shoe
 $\frac{1}{16}'' \times 1 \frac{3}{4}''$

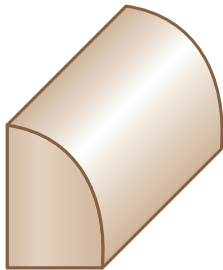

U835 Shoe
 $\frac{1}{2}'' \times \frac{3}{4}''$

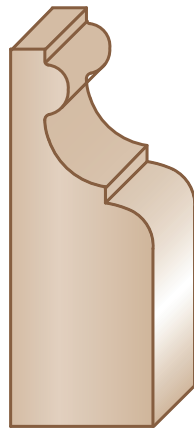

U836 Shoe
 $\frac{3}{4}'' \times 2''$

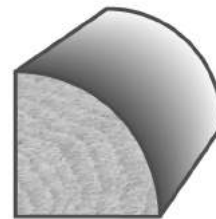

U830 Quarter Round
 $\frac{3}{4}'' \times \frac{3}{4}''$

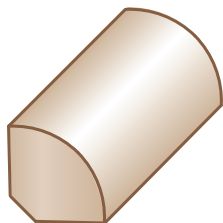

M530 Quarter Round
 a. $\frac{1}{2}'' \times \frac{1}{2}''$
 b. $\frac{1}{16}'' \times 1 \frac{1}{16}''$

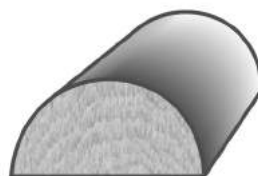

U832 Half Round
 $\frac{1}{2}'' \times 1''$

CHAIR RAIL MOULDING

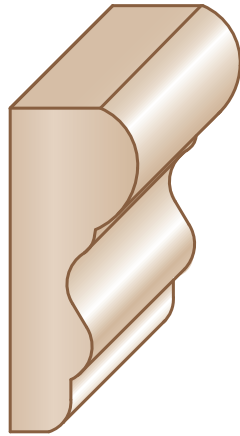

M600 Chair Rail
 $\frac{5}{8}'' \times 1 \frac{5}{8}''$

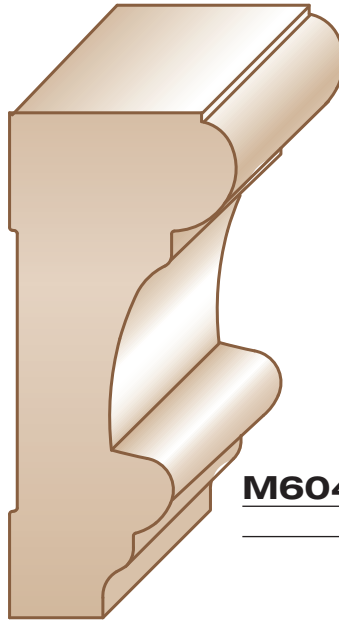

M604 Chair Rail
 $1 \frac{3}{16}'' \times 2 \frac{9}{16}''$

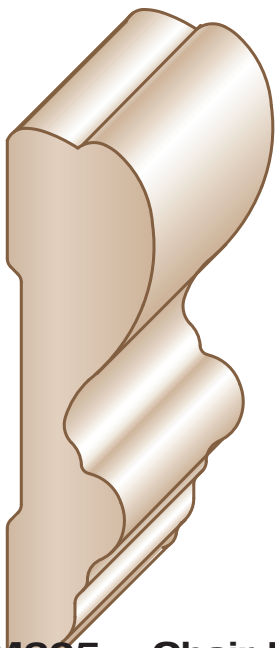

M605 Chair Rail
 $\frac{3}{4}'' \times 2 \frac{13}{16}''$

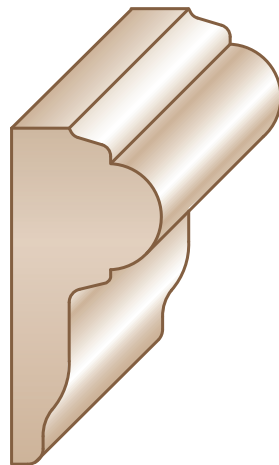

M608 Chair Rail
 $\frac{3}{4}'' \times 1 \frac{3}{4}''$

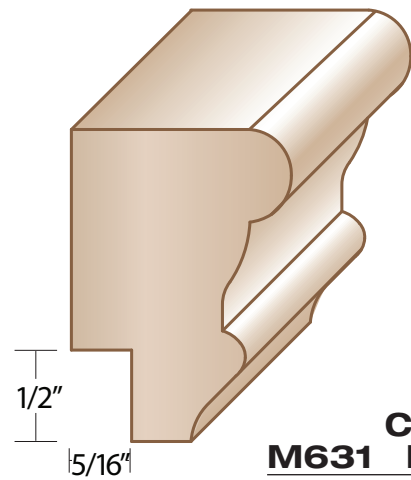

Chair Rail M631 Notched
 $1 \frac{1}{8}'' \times 1 \frac{5}{8}''$

CHAIR RAIL MOULDING CONTINUED



1/4"

U721 Chair Rail

3/4" x 1 5/8"

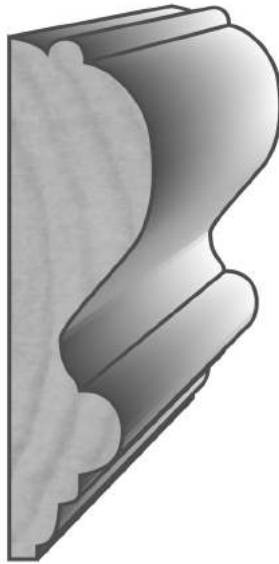

U722 Chair Rail

3/4" x 2 3/4"

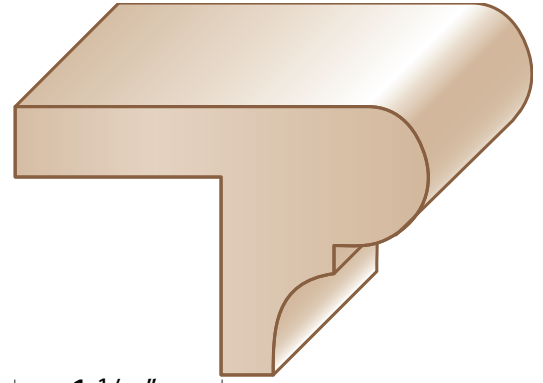

1 1/16"

**Rabbetted
U724 Chair Rail**

2 1/8" x 1 3/8"

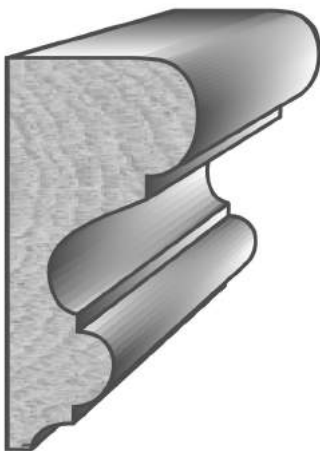

U750 Chair Rail

1" x 2"

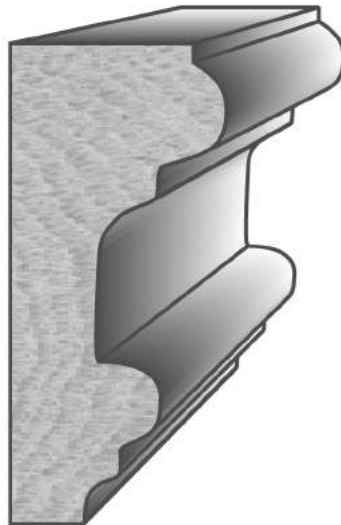

U751 Chair Rail

1 1/8" x 2 1/2"

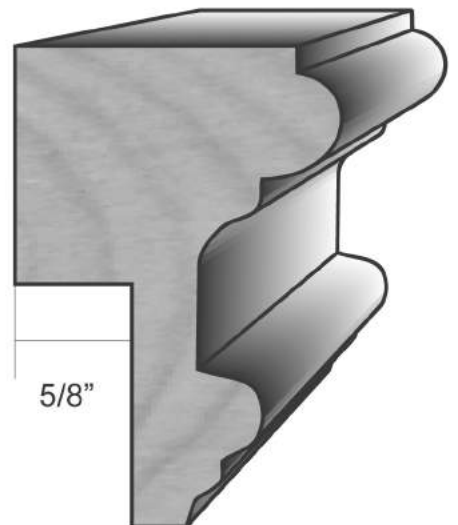

5/8"

**Rabbetted
U752 Chair Rail**

1 1/8" x 2 1/2"

CHAIR RAIL MOULDING CONTINUED

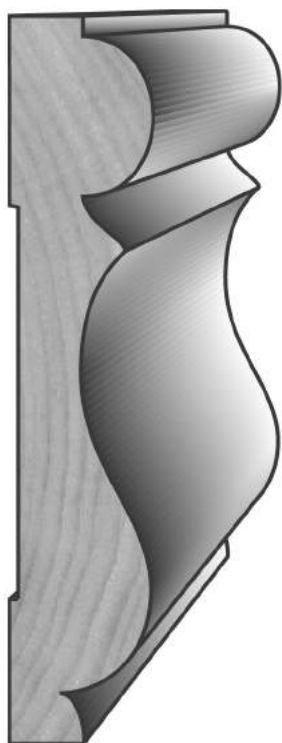

U753 Chair Rail
 $\frac{3}{4}'' \times 3\frac{3}{4}''$

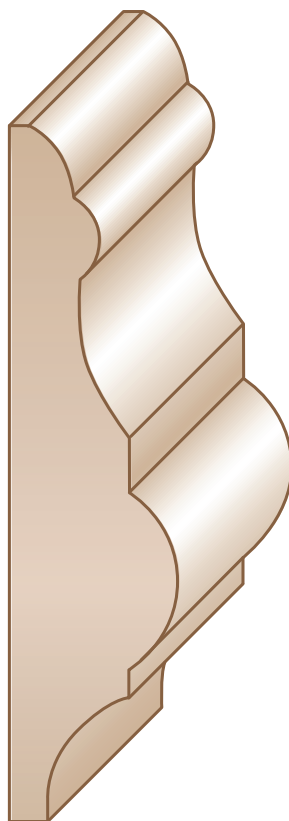

U754 Chair Rail
 $\frac{7}{8}'' \times 3\frac{5}{8}''$

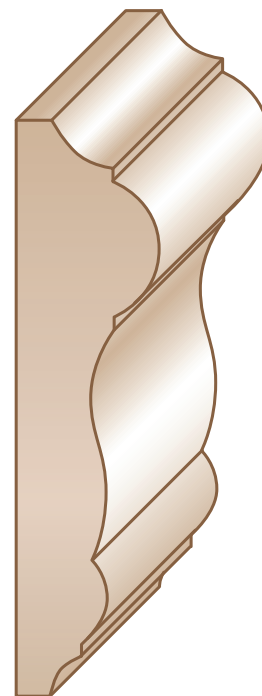

U756 Chair Rail
 $\frac{3}{4}'' \times 3''$

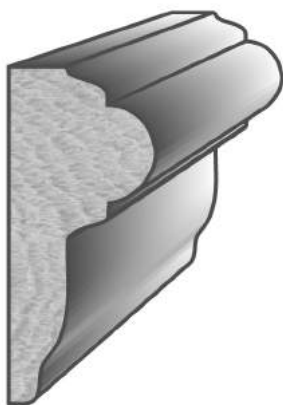

U759 Chair Rail
 $\frac{3}{4}'' \times 1\frac{3}{4}''$

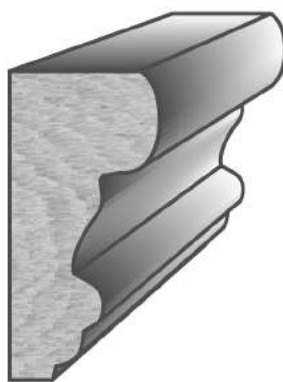

U761 Chair Rail
 $\frac{3}{4}'' \times 1\frac{5}{8}''$

CHAIR RAIL MOULDING CONTINUED

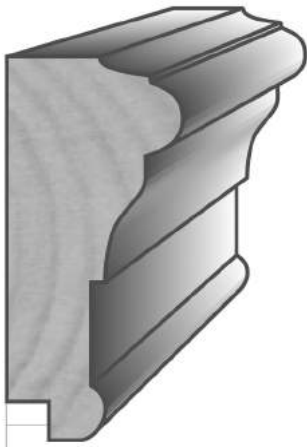

1/4" **Rabbetted**
U762 Chair Rail
7/8" x 2"

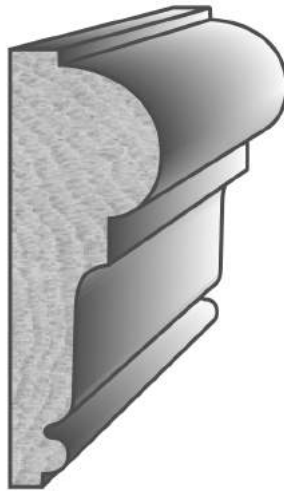

U780 Chair Rail
3/4" x 2 1/4"

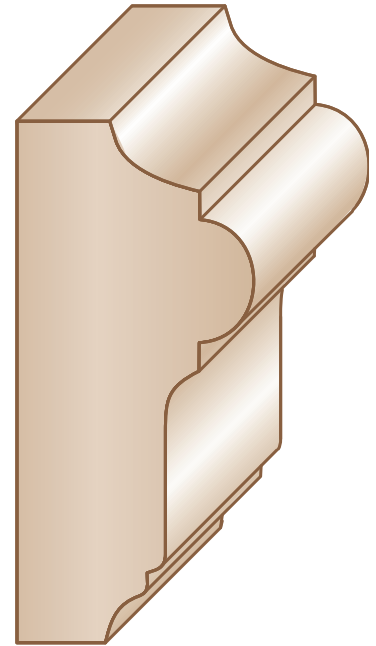

U782 Chair Rail
1 1/4" x 2 3/4"

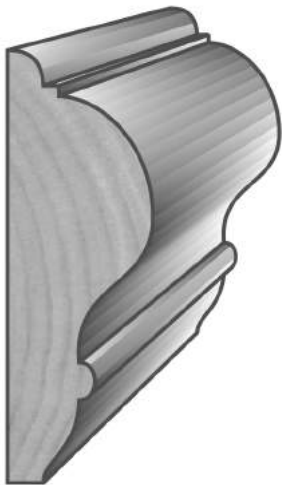

U783 Chair Rail
3/4" x 2 1/4"

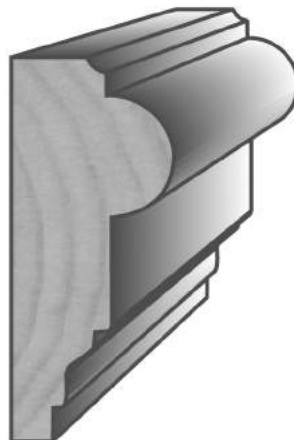

U786 Chair Rail
7/8" x 2"

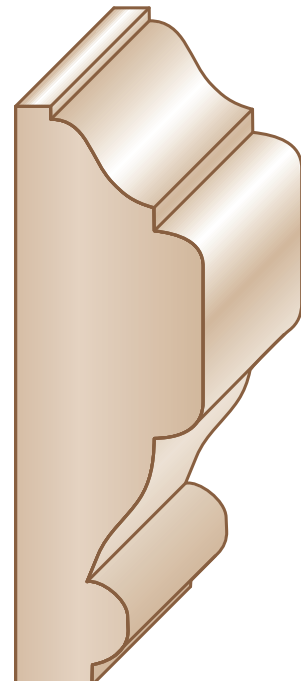

U787 Chair Rail
1" x 3"